



27" Integrated All Freezer— Tall

Integrated refrigeration can be used anywhere in the home. It merges seamlessly into the décor, with no visible hinges or grilles. Model 700TFI is a 27" wide tall unit with freezer storage in the upper cabinet and storage drawers.



Model 700TFI shown. Also shown is model 700BR refrigerator drawers and Wolf model R484CG gas range.

FEATURES

- Custom front panels and hardware allow for infinite design options.
- Point-of-use refrigeration that can be placed anywhere in the home.
- Microprocessor maintains precise control, within 1° of set temperature.
- Easy-access, illuminated touch control panel.
- Bright interior lighting in cabinet and drawers.
- Adjustable glass shelves and door shelves.
- Door alarm has an audible beep if door or drawer is left open.
- Automatic ice maker provides crescent shaped ice.
- 90° door stop built into hinge.
- Star-K compliant with harness kit.
- Meets U.S. Department of Energy standards.

MODEL

700TFI

Design

Integrated

INTERIOR FEATURES

- Freezer
 - 1 Temperature Zone
 - 3 Adjustable Wire Shelves
 - 1 Stationary Shelf
 - 2 Storage Drawers
 - 1 Removable Drawer Divider
 - 4 Adjustable Door Shelves
- Automatic Defrost
- Automatic Ice Maker

ACCESSORIES

- Stainless steel front panels with tubular or pro handles—80" or 84" finished height.
- Stainless steel tubular and pro handles.
- Dual installation kits for installation with column, tall or drawer model.

Accessories are available through your Sub-Zero dealer. For local dealer information, visit the find a showroom section of our website, subzero.com.





**27" Integrated
All Freezer— Tall**

OVERALL DIMENSIONS

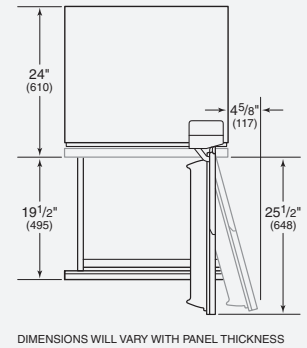
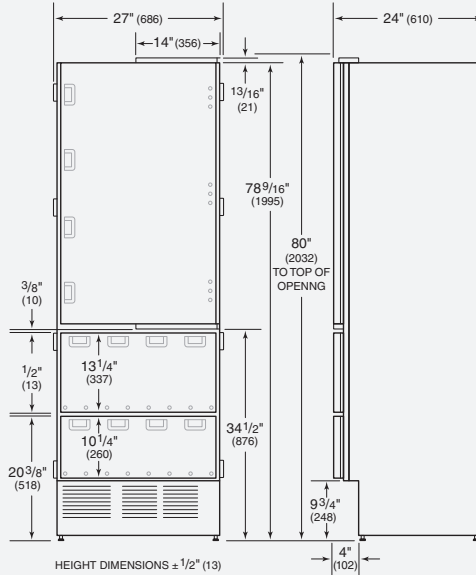

Unit dimensions may vary by ± 1/8".

SPECIFICATIONS

Overall Width	27"
Overall Height	80"
Overall Depth	24"
Door Clearance	25 1/2"
Drawer Clearance	19 1/2"
Freezer Capacity	15.3 cu ft
Finished Opening	27" W x 80" H x 25" D*
Electrical Requirements	115 V AC, 60 Hz 15 amp dedicated circuit
Plumbing Requirements	1/4" OD copper line 20–100 psi
Annual Energy Usage	\$70**
Shipping Weight	360 lbs

*Depth is 24" from the front of the unit to its back. Your design may necessitate moving the unit back, or cabinets forward to achieve a flush fit. This will require a minimum opening depth of 25".

**Based on 10.65 cents per kilowatt hour.

INSTALLATION SPECIFICATIONS

Opening Dimensions

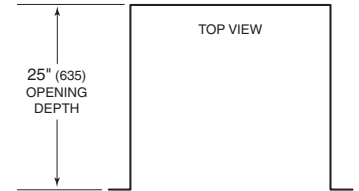
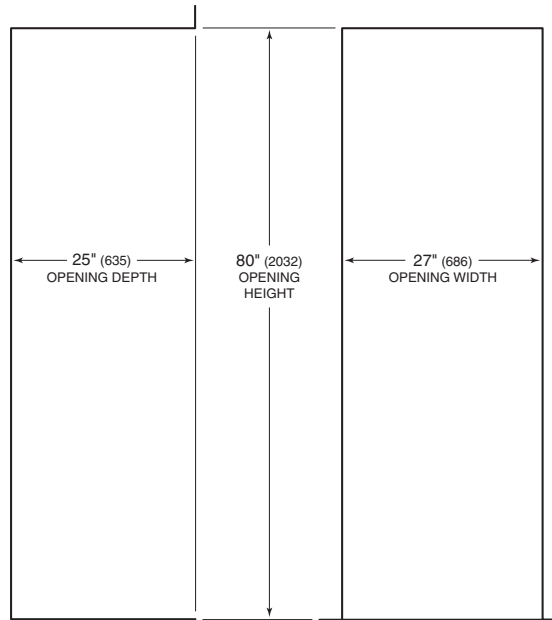

Dimensions in parentheses are in millimeters unless otherwise specified.

SIDE VIEW

FRONT VIEW

Location of Electrical Supply

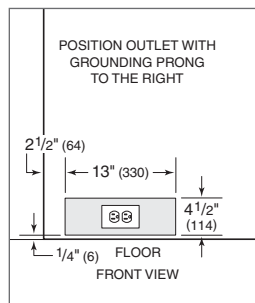

Location of Water Supply

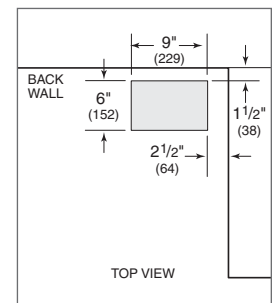
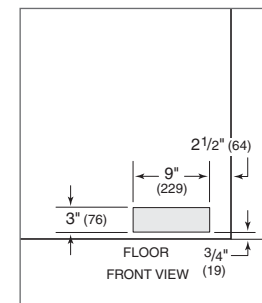

INSTALLATION NOTES

Stainless steel panels with handles are available as accessories. These panels are not installed at the factory.

Complete installation specifications, including panel sizes, can be found on our website, subzero.com/specs.